

Technical sheet :

MRT 2660

VISION +



Capacities		Metric
Max. capacity	Q	6000 kg
Max. lifting height	h3	25.9 m
Max. Reach	l4	21.7 m
Weight and dimensions		
Overall width	b1	2.5 m
Overall height	h17	3.1 m
Overall cab width	b4	0.96 m
Ground clearance	m4	0.36 m
Wheelbase	y	3.05 mm
Tilt-up angle	a4	12 °
Tilt-down angle	a5	112 °
Turret rotation		360 °
Overall weight		18000 kg
Forks length / width / section	l / e / s	1200 mm x 100 mm x 60 mm
Wheels		
Standard tyres		445/65 R22,5
Drive wheels (front / rear)		2 / 2
Steering mode		2 wheel steer, 4 wheel steer, Crab mode
Stabilisers		
Stabs Type		Telescopic Duplex
Controls with stabs		Stabs Commands Individual or Simultaneous
Engine		
Engine brand		Yanmar
Engine norm		EU Stage V / US EPA Tier 4
Engine model		4TN107FHT6SMU1
I.C. Engine power rating / Power (kW)		156 Hp / 115 kW
Max. torque / Engine rotation (min)		602 Nm @ 1500 rpm
Number of cylinders - Capacity of cylinders		4 - 4567 cm³
Engine cooling system		Water cooled
Number of batteries / Battery / Batteries capacity		2 x 12 V / 120 Ah
Battery starting current		(EN)850 A
Transmission		
Transmission type		Hydrostatic with Speedshift
Gearbox / Number of gears (forward) / Number of gears (reverse)		Speedshift 2 / 2
Max. travel speed		40 km/h
Parking brake		Automatic negative parking brake
Service brake		Oil-immersed multi-discs braking on front & rear axles
Hydraulics		
Hydraulic pump type		Load sensing pump
Hydraulic flow		185 l/min
Hydraulic Pressure		350 Bar
Tank capacities		
Engine oil		13 l
Hydraulic oil		260 l
Fuel tank		270 l
Diesel Exhaust fluid (AdBlue® type)		24 l
Miscellaneous		
Steering wheels (front / rear)		2 / 2
Controls		2 Joysticks
Safety cab homologation		ROPS - FOPS cab (level 2)
Attachment recognition system (E-Reco)		Standard

Dimensional drawing

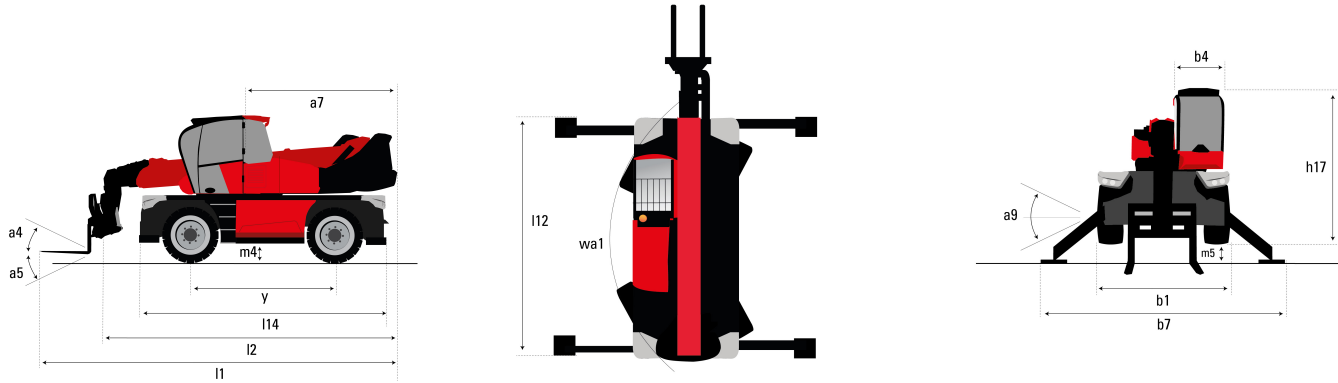

Other data		Metric
Overall length (with forks)	l1	9.28 m
Length to face of forks	l2	8.08 m
Length of frame	l14	5.69 m
Wheelbase	y	3.05 m
Ground clearance	m4	0.36 m
Counterweight offset (turret at 90°)	a7	3.5 m
Tilt-up angle	a4	12°
Tilt-down angle	a5	112°
Overall length at stabilisers	l12	5.3 m
External turning radius (over tyres)	wa1	4.22 m
Overall width	b1	2.5 m
Overall width with stabilisers extended	b7	578 mm
Overall cab width	b4	0.96 m
Overall height	h17	3.1 m
Frame levelling corrector	a9	+/- 7°
Ground clearance under front tires on stabilisers	m5	0.43 m

Load chart

Machine on lowered stabilisers with hook 6000 kg (Metric)

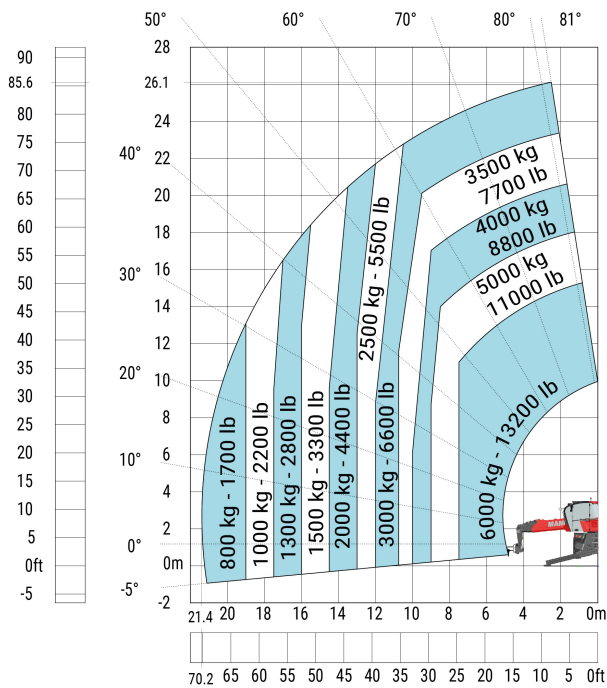

Machine on lowered stabilisers with winch 6000 kg (Metric)

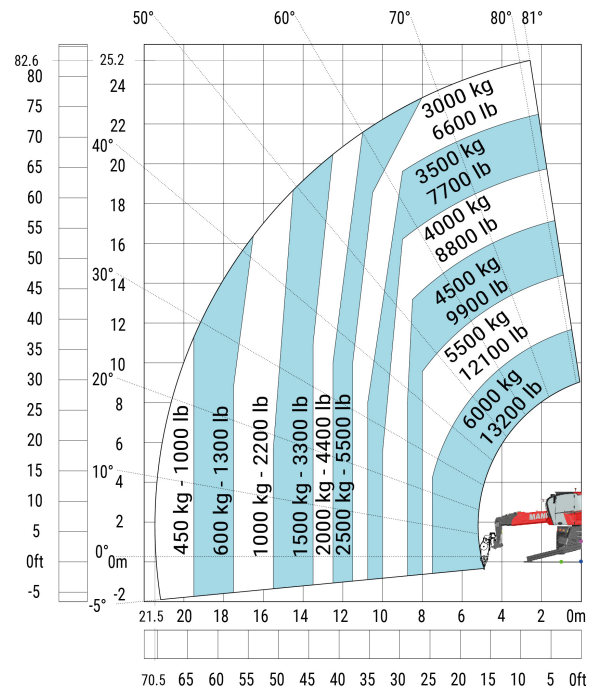

Machine on lowered stabilisers with forks Metric

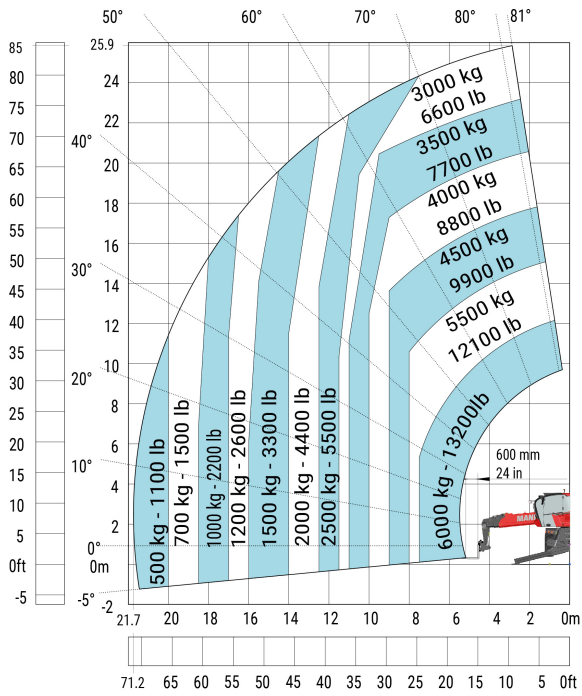

Machine on lowered stabilisers with 1500 kg jib Metric

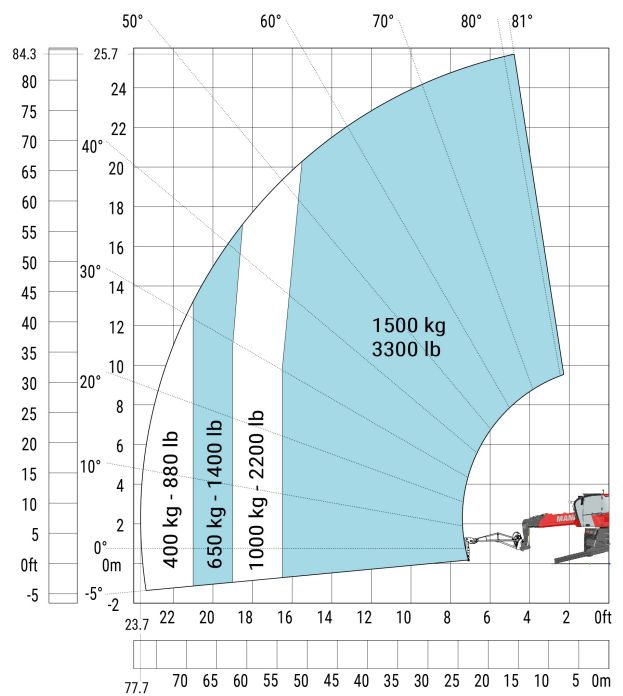

Machine on lowered stabilisers with 365 kg platform Metric

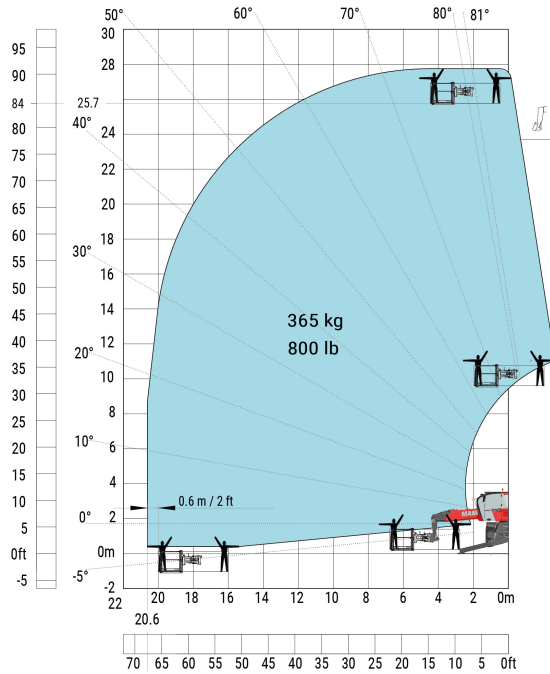

Machine on lowered stabilisers with 1000 kg platform Metric

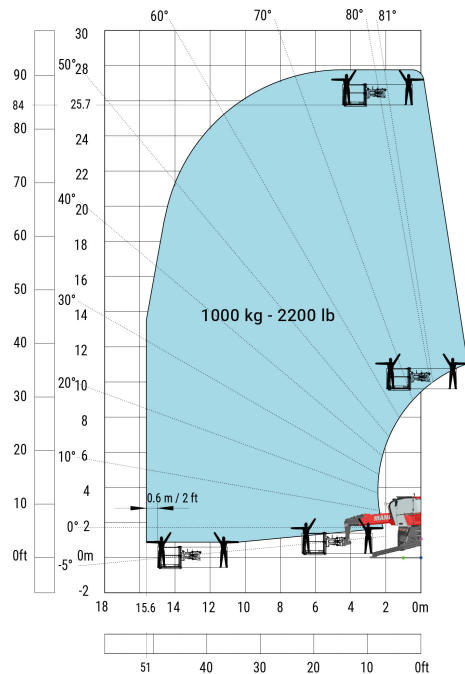

Machine on lowered stabilisers with 3D positive Metric

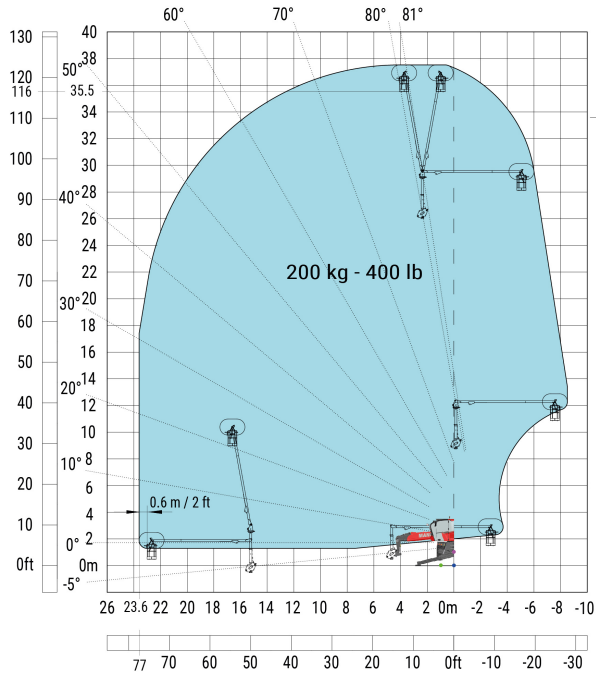

Machine on lowered stabilisers with 3D negative Metric

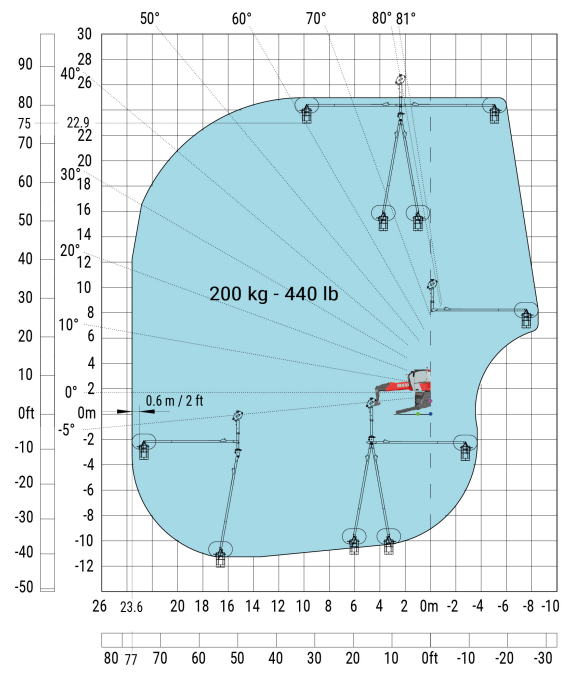

Machine on tyres with forks Metric

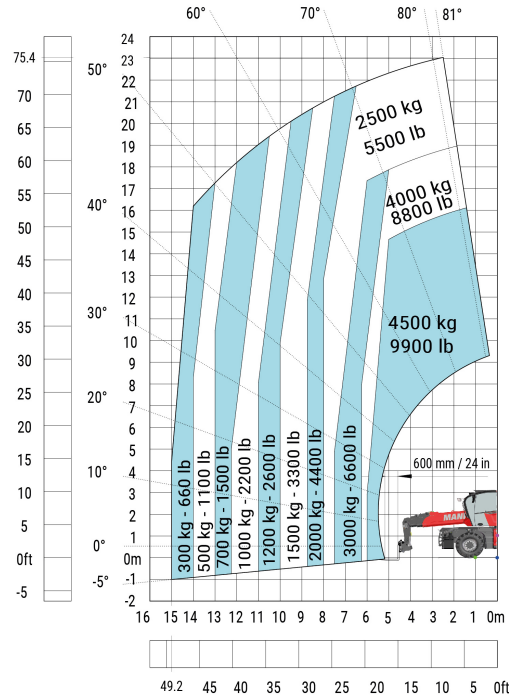



Siège Social

430 rue de l'Aubinière - 44150 Ancenis Cedex - France

Tel: +33(0)2 40 09 10 11 - Fax: +33 (0)2 40 09 10 97

www.manitou.com



This brochure describes versions and configuration options for Manitou products which may be fitted with different equipment. The equipment described in this brochure may be standard, optional or not available depending on version. Manitou reserves the right to change the specifications shown and described at any time and without prior warning. The manufacturer is not liable for the specifications given. For more information, contact your Manitou dealer. Non-contractual document. Product descriptions may differ from actual products. List of specifications is not comprehensive. The logos and visual identity of the company are the property of Manitou and may not be used without authorisation. All rights reserved. The photos and diagrams contained in this brochure are provided for information only.

MANITOU BF SA - Limited company with board of directors - Share capital: 39,668,399 euros - 857 802 508 RCS Nantes